

Laserprinter med scanner - Sort hvid A3

SHARP BP-51M36



Sharp BP-51C36 er en intelligent A3- sort/hvid-multifunktionsprinter med avancerede sikkerhedsfunktioner og miljøvenlige egenskaber – perfekt til den digitale arbejdsplads

- A3 sort/hvid-multifunktionsprinter med 36 sider pr. minut og problemfri integration med cloudbaserede forretningsapplikationer
- Flere lag af sikkerhedsfunktioner med automatisk BIOS-gendannelse ved afvigelser under opstart samt standard Trusted Platform Module til beskyttelse af fortrolige data
- Samarbejd nemt med Microsoft® Teams-forbindelsen – udskriv fra eller scan til dine Teams-kanaler direkte fra MFP'ens kontrolpanel*1
- Beskyt dine data, enhed og netværk med valgfrit Bitdefender anti-malware-beskyttelse*2
- Få større fleksibilitet i udskriftsresultatet med et bredt udvalg af efterbehandlingsmuligheder, herunder hæftning, hulning og foldning
- Et bæredygtigt design med op til 50 % genbrugsplast i fremstillingen af MFP-enhedens base og papemballage, hvilket reducerer plastaffald
- Scanningshastigheder op til 80 billeder pr. minut med vendbar dokumentføder i batches på op til 100 ark
- Avanceret miljøteknologi med en imponerende lav TEC-værdi og lavt strømforbrug i dvaletilstand
- Med understøttelse af Microsoft Entra ID kan du håndtere identiteter og kontrollere enhedsadgang via et sikkert cloudbaseret værktøj
- Intuitive ikoner og et smartphone-lignende interface på den 10,1-tommer farve-LCD-kontrolpanel
- Single sign-on gør det muligt at udskrive fra eller scanne til offentlige cloudlagringstjenester hurtigt og sikkert
- Hold dig opdateret og kompatibel med automatiske onlineopdateringer af firmware og applikationer via Sharp Application Portal

Konfiguration

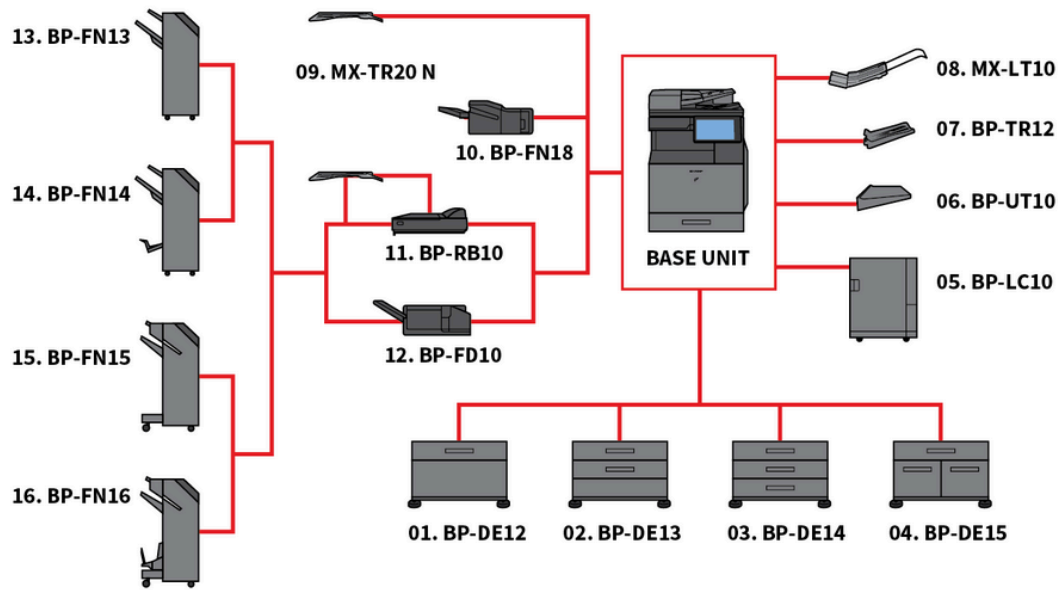

Dimensioner

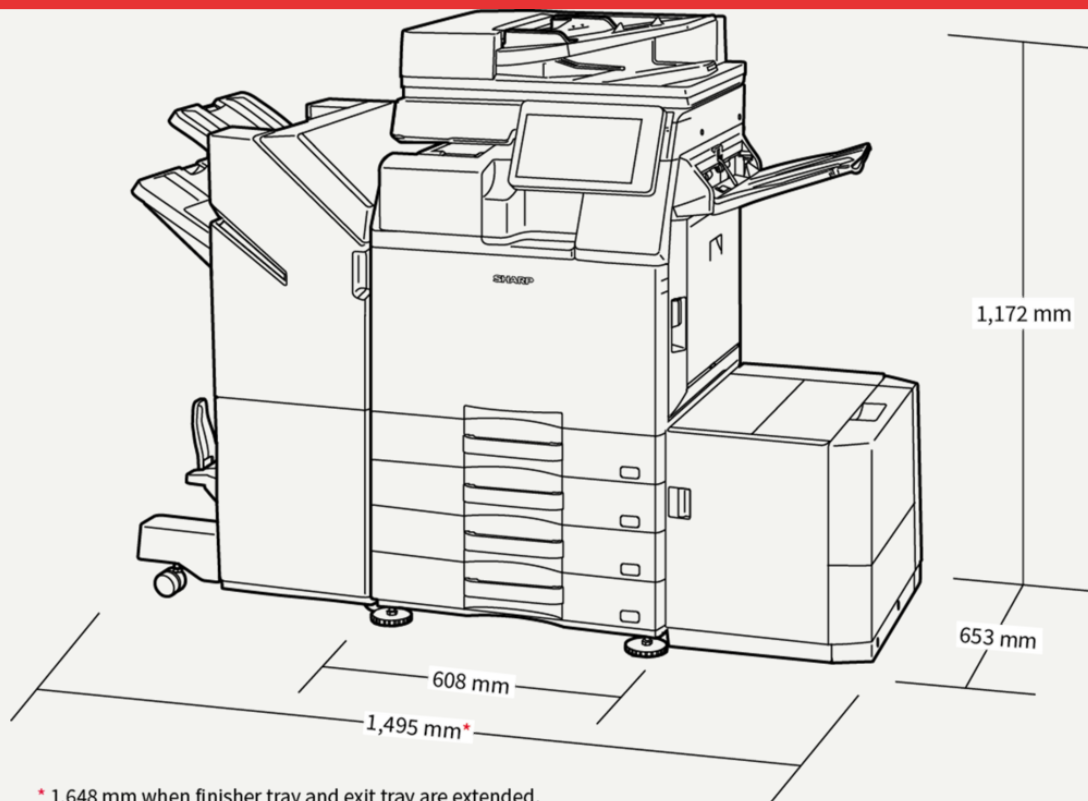

Options

Basis enhed

BP-LC10 Large Capacity Tray

3,000 sheets (based on 80 g/m²), A4-B5 (60-220 g/m²)

BP-DE14 Stand with 3 x 550-sheet Paper Drawers

550 sheets each for lower and upper trays (based on 80 g/m²), SRA3-A5R (60-300 g/m²)

BP-UT10 Utility Table

BP-DE13 Stand with 2 x 550-sheet Paper Drawers

550 sheets each for lower and upper trays (based on 80 g/m²), SRA3-A5R (60-300 g/m²)

BP-DE15 Stand with 550 + 2100-sheet Paper Drawers

Upper tray: SRA3-A5R, 550 sheets* (60-300 g/m²); Lower tray (Left): A4, 1,200 sheets* (60-105 g/m²); Lower tray (Right): A4 - B5, 900 sheets* (60-105 g/m²); * Number of sheets based on 80 g/m²

BP-DE12 Stand with 550-sheet Paper Drawer

550 sheets (based on 80 g/m²), SRA3-A5R (60-300 g/m²)

Scanning

MX-EB20 OCR Expansion Kit

Convert scanned documents into editable Microsoft® Office files and searchable PDFs via Optical Character Recognition (OCR).

Essential MFPs only

MX-EB19 Enhanced Compression Kit

Enables creation of high compression PDFs.

Trykning

MX-PF10 Barcode Font Kit

Enables barcode printing

MX-PU10 Direct Print Expansion Kit

Direct print Microsoft® Office files from USB drives. Essential MFPs only.

Sharp OSA

MX-AMX1 Application Integration Module

BP-AM11 External Account Module

BP-AM10 Application Communication Module

Sikkerhed

BP-FR12U Data Security Kit

Commercial version

BP-VD10 Virus Detection Kit

Opbevaring

BP-SD10 High Capacity SSD

512GB SSD

Fax

MX-FWX1

Efterbehandling

MX-LT10 Long Paper Feeding Tray

Recommended for banner printing

MX-PN15D Punch Module - 4 Hole Wide

Punch module for BP-FN13/BP-FN14/MX-FN28/MX-FN29

MX-PN14D Punch Module - 4 Hole Wide

Punch module for BP-FN11/BP-FN12

BP-FN14 1k Saddle Stitch Finisher

A3W-A5R (offset/staple), SRA3-A5R (non offset); Offset tray (upper): max. 1,000-sheet paper capacity (based on 80 g/m²); Stapling capacity: max. 50-sheet multi-position staple (based on 80 g/m²); Saddle stitch tray (lower): 7 sets (11-15 sheets), 10 sets (6-10 sheets), 20 sets (1-5 sheets). 15 sheets max per set; Requires BP-RB10 Paper Pass Unit

MX-PN16D Punch Module - 4 Hole Wide

Punch module for BP-FN15/BP-FN16/MX-FN30/MX-FN31/MX-FN34/MX-FN35

MX-PN15C Punch Module - 2/4 Hole

Punch module for BP-FN13/BP-FN14/MX-FN28/MX-FN29

MX-PN14C Punch Module - 2/4 Hole

Punch module for BP-FN11/BP-FN12

BP-FN13 1k Finisher

A3W-A5R (offset/staple), SRA3-A5R (non offset); Offset tray (upper): max. 1,000-sheet paper capacity (based on 80 g/m²); Stapling capacity: max. 50-sheet multi-position staple (based on 80 g/m²); Requires BP-RB10 Paper Pass Unit

BP-FD10 Folding Unit

200 sheets (based on 80 g/m²), A3, B4, A4R (Z-fold, half fold), A3, A4R (C-Fold, Accordion fold), 60-256 g/m²

MX-PN16C Punch Module - 2/4 Hole

Punch module for BP-FN15/BP-FN16/MX-FN30/MX-FN31/MX-FN34/MX-FN35

MX-PN15B Punch Module - 3 Hole

Punch module for BP-FN13/BP-FN14

MX-PN14B Punch Module - 3 Hole

Punch module for BP-FN11/BP-FN12

BP-TR12 Exit Tray Unit

BP-RB10 Paper Pass Unit

Required when using BP-FN13, BP-FN14, BP-FN15 or BP-FN16

BP-FN16 3k Saddle Stitch Finisher

A3-B5 (offset/staple), SRA3-A5R (non offset); Offset tray (upper): max. 3,000-sheet paper capacity (based on 80 g/m²); Stapling capacity: max. 65-sheet multi-position staple (based on 80 g/m²); Manual Stapling: 1-point at rear (Flat), 45 sheets (64 g/m²), 40 sheets (80 g/m²); Stapleless capacity: max. 10-sheet (64 g/m²), 8 sheet (65 - 81.4 g/m²), 6 sheet (81.5 - 105 g/m²); Saddle stitch tray (lower): 10 sets (11-20 sheets), 15 sets (6-10 sheets), 25 sets (1-5 sheets). 20 sheets max per set; Requires BP-RB10 Paper Pass Unit

MX-PN16B Punch Module - 3 Hole

Punch module for BP-FN15/BP-FN16

BP-FN15 3k Finisher

A3-B5 (offset/staple), SRA3-A5R (non offset); Offset tray (upper): max. 3,000-sheet paper capacity (based on 80 g/m²); Stapling capacity: max. 65-sheet multi-position staple (based on 80 g/m²); Manual Stapling: 1-point at rear (Flat), 45 sheets (64 g/m²), 40 sheets (80 g/m²); Stapleless capacity: max. 10-sheet (64 g/m²), 8 sheet (65 - 81.4 g/m²), 6 sheet (81.5 - 105 g/m²); Requires BP-RB10 Paper Pass Unit

BP-FN18 Inner Finisher

A3 - B5 (offset/staple), SRA3 - A5R (non offset); Offset tray (upper): max. 500-sheet paper capacity*; Stapling capacity: max. 50-sheet multi-position staple*; Manual Stapling: 1-point at rear (Flat), 45 sheets (64 g/m²), 40 sheets (80 g/m²); Stapleless capacity: max.10-sheet (64 g/m²), 8 sheet (65 - 81.4 g/m²), 6 sheet (81.5 - 105 g/m²)

Specifikationer

Generelt

Hastighed - s/h sider pr. minut (A4)	36
Teknologi	18
Papir størrelse: Min.	A6R
Papir størrelse: Max.	A3W
Papir vægt: Min. (g/m ²)	60
Papir vægt: Max. (g/m ²)	300
Papirvægt multi-bypass min. (g/m ²)	52
Papirvægt: multi-bypass max. (g/m ²)	300
Papirkapacitet :Standard (ark)	650
Papirkapacitet :Max (ark)	6300
Opvarmningstid (sek.)	13
Hukommelse general: Max.(GB)	5
[MFPSpecificationStorageStd]	SSD
[MFPSpecificationStorageOpt]	SSD
[MFPSpecificationSsdCapStdGb]	128
[MFPSpecificationSsdCapOptGb]	512
Duplex	Std.
Strømkraft: frekvens min (Hz)	50
Strømkraft: frekvens max (Hz)	60
Strømforbrug (kW)	1,84
Kontrol panel størrelse (")	10,1
Base Unit bredde (mm)	608
Base Unit dybde (mm)	653
Base Unit højde (mm)	829
Vægt (kg)	64
Strømkraft: spænding (V)	220
Strømkraft: spænding (V)	240

Fax

Fax	Opt.
Kompressionsmetode	MH, MR, MMR, JBIG
Kommunikationsprotokol	Super G3, G3
Overførselshastighed (sek.)	2
Modem hastighed: Min. (bps)	2400
Modem hastighed: Max. (bps)	33600
Overførselsopløsning: Std (dpi)	203.2 x 97.8
Overførselsopløsning: Ultra Fine (dpi)	406.4 x 391
Dokument størrelse (min.)	A5
Dokument størrelse (max.)	A3
Hukommelse: Max (GB)	4
Gråtone niveauer	256
Registrering af indkommende / udgående fax	2000
Gruppesending	500

Trådløst LAN

Trådløst LAN	Opt.
Gældende regelsæt	IEEE802.11a/ac/b/g/n
Adgangstilstand	Infrastructure mode, Software AP mode
Sikkerhed	WEP, WPA/WPA2-mixed PSK, WPA/WPA2-mixed EAP, WPA2 PSK, WPA2 EAP, WPA2/WPA3-mixed, PSK/SAE, WPA3 SAE, WPA3, EAP

Efterbehandler

Kapacitet. Min. (sider)	500
Kapacitet. Max. (sider)	3250
Hæfte kapacitet Max. (sider)	65
Falsning (folde-funktion)	Opt.
Off-set forskydning	Std.
Hulle funktion	Opt.
Falsning	Opt.

Print

Netværksprinter	Std.
Opløsning (dpi)	600 x 600, 9600 x 600
Interface: Std.	USB 2.0, USB 3.0, 10Base-T, 100Base-TX, 1000Base-T
Interface: Opt.	Secondary LAN support
Understøttede operativsystemer (standard)	Windows 10, Windows 11, Windows Server 2016, Windows Server 2019, Windows Server 2022, Windows Server 2025
Understøttede operativsystemer (tilbehør)	Mac OS X 10.15, Mac OS X 11, Mac OS X 12, Mac OS X 13, Mac OS X 14, macOS 15
Netværksprotokoller	TCP/IP
Printerprotokoller	LPR, Raw TCP (port 9100), POP3 (e-mail printing), HTTP, FPT for downloading print files, IPP, SMB, WSD
PDL: Std.	PCL6, Adobe® PostScript® 3™
Tilgængelig fonte	80 PCL, 139 PostScript 3

Scan

Scanningsmetode	Std.
Scanneropløsning - "push" scan (dpi)	100, 150, 200, 300, 400, 600
Scanneropløsning - "pull" scan (dpi)	75, 100, 150, 200, 300, 400, 600, 50-9600
Dokument feeder	RSPF
Dokument feeder kapacitet (sider)	100
[MFPSpecificationScanSpeedColourSimplexOpm]	80
Fil formater (standard)	TIFF, PDF, PDF/A-1b, Encrypted PDF, JPEG, XPS
Fil formater (tilbehør)	PDF/A-1a, Compact PDF, Searchable PDF, Microsoft Office (pptx, xlsx, docx), Text (TXT), Rich Text (RFT)
Scandestinationer	Desktop, FTP, Email, Netværksmappe, USB hukommelse

Kopi

Original papir størrelse Max.	A3
1. s/h kopi (sek.)	4,5
E-sift	Std.
Kontinuerlig kopiering (max. kopier)	9999
Scanneropløsning ved s/h (dpi)	600 x 600, 600 x 400
Scanneropløsning ved farve (dpi)	600 x 600
Printeropløsning	600 x 600, 9600 x 600
Gradueringer - farve	256
Gradueringer - s/h	2
Zoom rækkevidde: Min (%)	25
Zoom rækkevidde: Max (%)	400
Faste zoom-satser	10
Netværksscanner	Push scan, Pull scan

Filer

Dokument filer	Std.
Kapacitet: hoved- og brugermapper (sider)	5000
Kapacitet: hurtig mapper (sider)	5000
Lagret jobs	Copy, Print, Scan, Fax transmission
Lagringsmappe	Quick file, Main, Custom (Max 1000)

Toner Indhold

Sort (sider med 6% dæklade)	40000
-----------------------------	-------

