

Laserprinter med scanner - Sort hvid A3

BP-50M31



BP-50M31 A3 SH MFP er en sikker printløsning til fremtidens arbejdsplads.

- 31 sider pr. min. SH MFP med problemfri integration og forbindelse til skybaserede forretningsprocesapplikationer
- Funktionsrig hardware- og løsningsplatform, der understøtter det hybride arbejdsmiljø
- Indbygget Microsoft® Teams-connector (option) styrker samarbejdet ved at muliggøre direkte og sikker adgang til udskrivning til eller scanning fra dine Microsoft® Teams-kanaler
- Brancheførende system- og databeskyttelsesfunktioner, herunder BIOS-baseret sikkerhed og standard Trusted Platform Module, sikrer, at fortrolige data holdes sikre
- Hold dine data, din enhed og dit netværk sikkert med Bitdefender antimalwarebeskyttelsessoftware (ekstraudstyr)
- Interager med MFP'en direkte fra din mobile enhed via WiFi, AirPrint (option), Bluetooth, NFC og QR-kode
- Udskriv sikkert fra eller scan til offentlige cloudlagertjenester hurtigt og nemt med enkeltlogon
- 10.1-tommer farve LCD-kontrolpanel tilbyder en smartphone-stil brugergrænseflade, der gør alt let at få adgang til og bruge
- Omfattende efterbehandlingsmuligheder, herunder en foldeenhed, giver endnu mere fleksibilitet til dit udskriftsoutput
- Overlegen miljøpræstation giver lavere standbystrømforbrug og lav TEC-værdi
- Hold dig opdateret og kompatibel med eksterne firmware- og programopdateringer via Sharp Application Portal
- 100-arks reverserende single pass feeder scanner en eller tosidede originaler med hastigheder på op til 80ipm for at fuldføre store opgaver med lethed og effektivitet

Konfiguration



Dimensioner

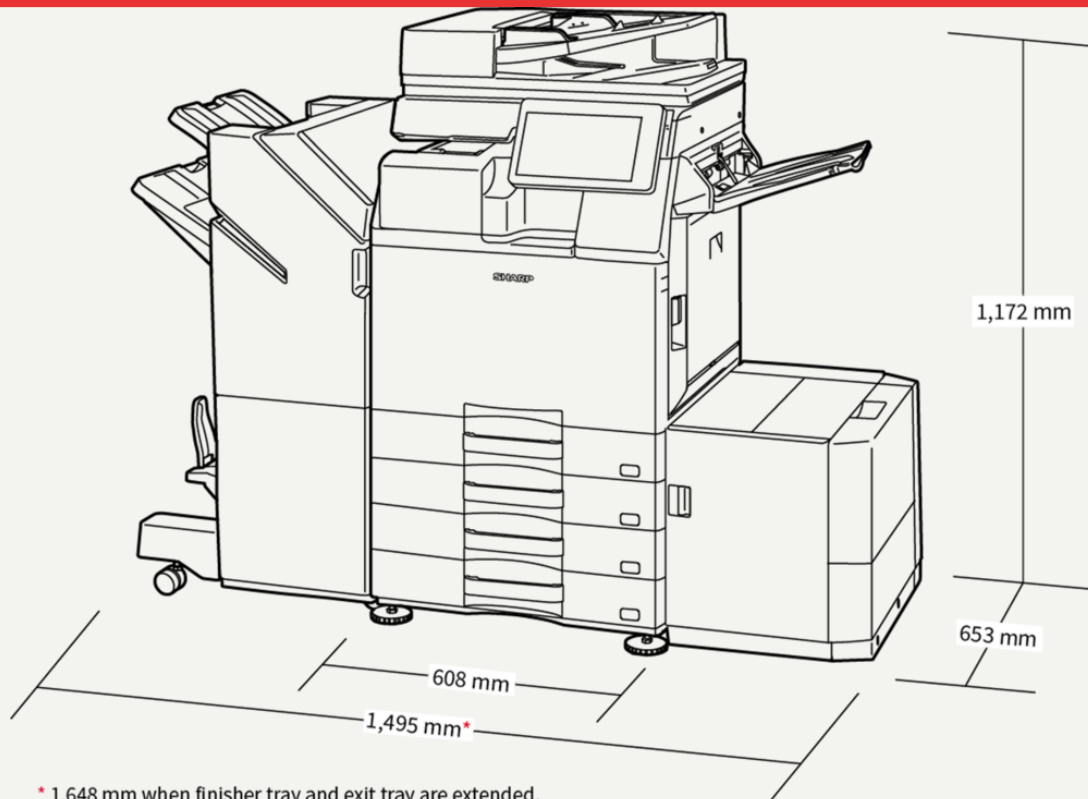

Options

Basis enhed

BP-LC10 Large Capacity Tray

3,000 sheets (based on 80 g/m²), A4-B5 (60-220 g/m²)

BP-DE14 Stand with 3 x 550-sheet Paper Drawers

550 sheets each for lower and upper trays (based on 80 g/m²), SRA3-A5R (60-300 g/m²)

BP-UT10 Utility Table

BP-DE13 Stand with 2 x 550-sheet Paper Drawers

550 sheets each for lower and upper trays (based on 80 g/m²), SRA3-A5R (60-300 g/m²)

BP-DE15 Stand with 550 + 2100-sheet Paper Drawers

Upper tray: SRA3-A5R, 550 sheets* (60-300 g/m²); Lower tray (Left): A4, 1,200 sheets* (60-105 g/m²); Lower tray (Right): A4 - B5, 900 sheets* (60-105 g/m²); * Number of sheets based on 80 g/m²

BP-DE12 Stand with 550-sheet Paper Drawer

550 sheets (based on 80 g/m²), SRA3-A5R (60-300 g/m²)

Scanning

MX-EB20 OCR Expansion Kit

Convert scanned documents into editable Microsoft® Office files and searchable PDFs via Optical Character Recognition (OCR).

Essential MFPs only

MX-EB19 Enhanced Compression Kit

Enables creation of high compression PDFs.

Trykning

MX-PF10 Barcode Font Kit

Enables barcode printing

MX-PK13 PS3 Expansion Kit

Adobe PostScript®3™ expansion kit. Essential MFPs only.

MX-PU10 Direct Print Expansion Kit

Direct print Microsoft® Office files from USB drives. Essential MFPs only.

Sharp OSA

MX-AMX1 Application Integration Module

BP-AM11 External Account Module

BP-AM10 Application Communication Module

Sikkerhed

BP-FR12U Data Security Kit

Commercial version

BP-VD10 Virus Detection Kit

Forbindelse

BP-EB10 Wireless Connection Adaptor

Enables connection to wireless networks

Opbevaring

BP-SD10 High Capacity SSD

512GB SSD

Fax

MX-FWX1

BP-FX11 Fax Expansion Kit

Efterbehandling

MX-LT10 Long Paper Feeding Tray

Recommended for banner printing

MX-PN15D Punch Module - 4 Hole Wide

Punch module for BP-FN13/BP-FN14/MX-FN28/MX-FN29

MX-PN14D Punch Module - 4 Hole Wide

Punch module for BP-FN11/BP-FN12

BP-TU10 Exit Tray Cabinet

BP-FN14 1k Saddle Stitch Finisher

A3W-A5R (offset/staple), SRA3-A5R (non offset); Offset tray (upper): max. 1,000-sheet paper capacity (based on 80 g/m²); Stapling capacity: max. 50-sheet multi-position staple (based on 80 g/m²); Saddle stitch tray (lower): 7 sets (11-15 sheets), 10 sets (6-10 sheets), 20 sets (1-5 sheets). 15 sheets max per set; Requires BP-RB10 Paper Pass Unit

MX-PN16D Punch Module - 4 Hole Wide

Punch module for BP-FN15/BP-FN16/MX-FN30/MX-FN31/MX-FN34/MX-FN35

MX-PN15C Punch Module - 2/4 Hole

Punch module for BP-FN13/BP-FN14/MX-FN28/MX-FN29

MX-PN14C Punch Module - 2/4 Hole

Punch module for BP-FN11/BP-FN12

BP-FN13 1k Finisher

A3W-A5R (offset/staple), SRA3-A5R (non offset); Offset tray (upper): max. 1,000-sheet paper capacity (based on 80 g/m²); Stapling capacity: max. 50-sheet multi-position staple (based on 80 g/m²); Requires BP-RB10 Paper Pass Unit

BP-FD10 Folding Unit

200 sheets (based on 80 g/m²), A3, B4, A4R (Z-fold, half fold), A3, A4R (C-Fold, Accordion fold), 60-256 g/m²

MX-PN16C Punch Module - 2/4 Hole

Punch module for BP-FN15/BP-FN16/MX-FN30/MX-FN31/MX-FN34/MX-FN35

MX-PN15B Punch Module - 3 Hole

Punch module for BP-FN13/BP-FN14

MX-PN14B Punch Module - 3 Hole

Punch module for BP-FN11/BP-FN12

BP-TR12 Exit Tray Unit

BP-RB10 Paper Pass Unit

Required when using BP-FN13, BP-FN14, BP-FN15 or BP-FN16

BP-FN16 3k Saddle Stitch Finisher

A3-B5 (offset/staple), SRA3-A5R (non offset); Offset tray (upper): max. 3,000-sheet paper capacity (based on 80 g/m²); Stapling capacity: max. 65-sheet multi-position staple (based on 80 g/m²); Manual Stapling: 1-point at rear (Flat), 45 sheets (64 g/m²), 40 sheets (80 g/m²); Stapleless capacity: max. 10-sheet (64 g/m²), 8 sheet (65 - 81.4 g/m²), 6 sheet (81.5 - 105 g/m²); Saddle stitch tray (lower): 10 sets (11-20 sheets), 15 sets (6-10 sheets), 25 sets (1-5 sheets). 20 sheets max per set; Requires BP-RB10 Paper Pass Unit

BP-FN11 Inner Finisher

A3 - B5 (offset/staple), SRA3 - A5R (non offset); Offset tray (upper): max. 500-sheet paper capacity (based on 80 g/m²); Stapling capacity: max. 50-sheet multi-position staple (based on 80 g/m²); Manual Stapling: 1-point at rear (Flat), 45 sheets (64 g/m²), 40 sheets (80 g/m²); Stapleless capacity: max.10-sheet (64 g/m²), 8 sheet (65-81.4 g/m²), 6 sheet (81.5 - 105 g/m²); Requires BP-RB10 Paper Pass Unit

MX-PN16B Punch Module - 3 Hole

Punch module for BP-FN15/BP-FN16

BP-FN15 3k Finisher

A3-B5 (offset/staple), SRA3-A5R (non offset); Offset tray (upper): max. 3,000-sheet paper capacity (based on 80 g/m²); Stapling capacity: max. 65-sheet multi-position staple (based on 80 g/m²); Manual Stapling: 1-point at rear (Flat), 45 sheets (64 g/m²), 40 sheets (80 g/m²); Stapleless capacity: max. 10-sheet (64 g/m²), 8 sheet (65 - 81.4 g/m²), 6 sheet (81.5 - 105 g/m²); Requires BP-RB10 Paper Pass Unit

Specifikationer

Generelt

Hastighed - s/h sider pr. minut (A4)	31
Teknologi	15
Papir størrelse: Min.	A6R
Papir størrelse: Max.	A3W
Papir vægt: Min. (g/m ²)	60
Papir vægt: Max. (g/m ²)	300
Papirkapacitet :Standard (ark)	650
Papirkapacitet :Max (ark)	6300
Opvarmningstid (sek.)	13
Hukommelse general: Max.(GB)	5
[MFPSpecificationStorageStd]	SSD
[MFPSpecificationStorageOpt]	SSD
[MFPSpecificationSsdCapStdGb]	128
[MFPSpecificationSsdCapOptGb]	512
Duplex	Std.
Strømkrav: frekvens min (Hz)	50
Strømkrav: frekvens min (Hz)	60
Strømforbrug (kW)	1,84
Base Unit bredde (mm)	608
Base Unit dybde (mm)	653
Base Unit højde (mm)	829
Vægt (kg)	64
Strømkrav: spænding (V)	220
Strømkrav: spænding (V)	240

Kopi

Original papir størrelse Max.	A3
1. s/h kopi (sek.)	5,4
E-sift	Opt.
Kontinuerlig kopiering (max. kopier)	9999
Scanneropløsning ved s/h (dpi)	600 x 600, 600 x 400
Scanneropløsning ved farve (dpi)	600 x 600
Printeropløsning	600 x 600, 9600 x 600
Gradueringer - farve	256
Gradueringer - s/h	2
Zoom rækkevidde: Min (%)	25
Zoom rækkevidde: Max (%)	400
Faste zoom-satser	10
Netværksscanner	Push scan, Pull scan

Trådløst LAN

Trådløst LAN	Opt.
Gældende regelsæt	IEEE802.11a/ac/b/g/n
Adgangstilstand	Infrastructure mode, Software AP mode
Sikkerhed	WEP, WPA/WPA2-mixed PSK, WPA/WPA2-mixed EAP, WPA2 PSK, WPA2 EAP, WPA2 EAP/WPA3-mixed, PSK/SAE, WPA3 SAE, WPA2/WPA3-mixed, EAP, WPA3 EAP

Filer

Dokument filer	Std.
Lagret jobs	Copy, Print, Scan, Fax transmission
Lagringsmappe	Quick file, Main, Custom (Max 1000)

Print

Netværksprinter	Std.
Opløsning (dpi)	600 x 600, 9600 x 600
Interface: Std.	USB 2.0, USB 3.0, 10Base-T, 100Base-TX, 1000Base-T
Understøttede operativsystemer (standard)	Windows 8.1, Windows 10, Windows 11, Windows Server 2012, Windows Server 2012R2, Windows Server 2016, Windows Server 2019
Understøttede operativsystemer (tilbehør)	Mac OS X 10.10, Mac OS X 10.11, Mac OS X 10.12, Mac OS X 10.13, Mac OS X 10.14, Mac OS X 10.15, Mac OS X 11, Mac OS X 12
Netværksprotokoller	TCP/IP (IPv4, IPv6)
Printerprotokoller	LPR, Raw TCP (port 9100), POP3 (e-mail printing), HTTP, FPT for downloading print files, IPP, SMB, WSD
Tilgængelig fonte	80 PCL, 139 PostScript 3

Fax

Fax	Opt.
Kompressionsmetode	MH, MR, MMR, JBIG
Kommunikationsprotokol	Super G3, G3
Overførselshastighed (sek.)	2
Modem hastighed: Min. (bps)	2400
Modem hastighed: Max. (bps)	33600
Overførselsopløsning: Std (dpi)	203.2 x 97.8 dpi
Overførselsopløsning: Ultra Fine (dpi)	406.4 x 391 dpi
Dokument størrelse (min.)	A5
Dokument størrelse (max.)	A3
Hukommelse: Max (GB)	4
Gråtone niveauer	256
Registrering af indkommende / udgående fax	2000
Gruppesending	500

Scan

Scanningsmetode	Std.
Scanneropløsning - "push" scan (dpi)	100, 150, 200, 300, 400, 600
Scanneropløsning - "pull" scan (dpi)	75, 100, 150, 200, 300, 400, 600, 50-9600
Fil formater (standard)	TIFF, PDF, PDF/A-1a, PDF/A-1b, Encrypted PDF, Compact PDF, JPEG, XPS, Searchable PDF, Microsoft Office (pptx, xlsx, docx), Text (TXT), Rich Text (RFT)
Scandestinationer	Desktop, FTP, Email, Netværksmappe, USB hukommelse

Efterbehandler

Kapacitet. Min. (sider)	500
Kapacitet. Max. (sider)	3000
Hæfte kapacitet Max. (sider)	65
Falsning (folde-funktion)	Opt.
Off-set forskydning	Std.
Hulle funktion	Opt.

Toner Indhold

Sort (sider med 6% dækflade)	40000
------------------------------	-------

